



Pompe centrifughe bi-giranti adatte alla realizzazione di gruppi di pressurizzazioni per impianti civili e industriali; le due giranti contrapposte garantiscono una elevata prevalenza garantendo comunque una buona portata.

Two impeller centrifugal pumps for constructing pressurisation systems for civil and industrial plant; the two counter-posed impellers guarantee high head with good delivery.

Bombas centrifugas con doble rodete apropiadas para realizar unidades de presurización para instalaciones civiles e industriales; los dos rodetes contrapuestos garantizan una elevada prevalencia garantizando en cualquier caso un buen caudal.

Pompes centrifuges à deux turbines, aptes à la réalisation de groupes de surpression pour installations civiles et industrielles; les deux roues opposées garantissent une hauteur manométrique élevée tout en maintenant un débit excellent.

CARATTERISTICHE COSTRUTTIVE / CONSTRUCTION FEATURES CARACTERÍSTICAS CONSTRUCTIVAS / CARACTÉRISTIQUES D'EXÉCUTION

Corpo pompa	ghisa
Pump body	cast iron
Cuerpo bomba	fundición
Corps de pompe	fonte
Supporto motore	ghisa
Motor bracket	cast iron
Soporte motor	fundición
Support moteur	fonte
Girante	ottone o Noryl® (CB100÷900) ottone (CB800÷1500)
Impeller	brass or Noryl® (CB100÷900) brass (CB800÷1500)
Rodete	latón o Noryl® (CB100÷900) latón (CB800÷1500)
Turbine	laiton ou Noryl® (CB100÷900) laiton (CB800÷1500)
Tenuta meccanica	ceramica-grafite
Mechanical seal	ceramic-graphite
Sello mecánico	cerámica-grafito
Garniture mécanique	céramique-graphite
Albero motore	acciaio AISI 303 acciaio AISI 416 (CB100)
Motor shaft	stainless steel AISI 303 stainless steel AISI 416 (CB100)
Eje motor	acero AISI 303 acero AISI 416 (CB100)
Arbre moteur	acier AISI 303 acier AISI 416 (CB100)
Temperatura del liquido	girante Noryl®: 0 - 50 °C girante ottone: 0 - 90 °C
Liquid temperature	Noryl® impeller: 0 - 50 °C brass impeller: 0 - 90 °C
Temperatura del líquido	rodete de Noryl®: 0 - 50 °C rodete latón: 0 - 90 °C
Température du liquide	turbine en Noryl®: 0 - 50 °C turbine laiton: 0 - 90 °C
Pressione di esercizio	
Operating pressure	max 6 bar (CB100)
Presión de trabajo	max 11 bar (CB160-1500)
Pression de fonctionnement	
MOTORE / MOTOR / MOTOR / MOTEUR	
Motore 2 poli a induzione	3~ 230/400V-50Hz P ≤ 4kW 3~ 400/690V-50Hz P > 4kW
2 pole induction motor	1~ 230V-50Hz (con termoprotettore with thermal protection con protección térmica avec protection thermique)
Motor de 2 polos a inducción	
Moteur à induction à 2 pôles	
Classe di isolamento	
Insulation class	F
Clase de aislamiento	
Classe d'isolation	
Grado di protezione	
Protection degree	IP44
Grado de protección	IP55 (CB800÷1500)
Protection	

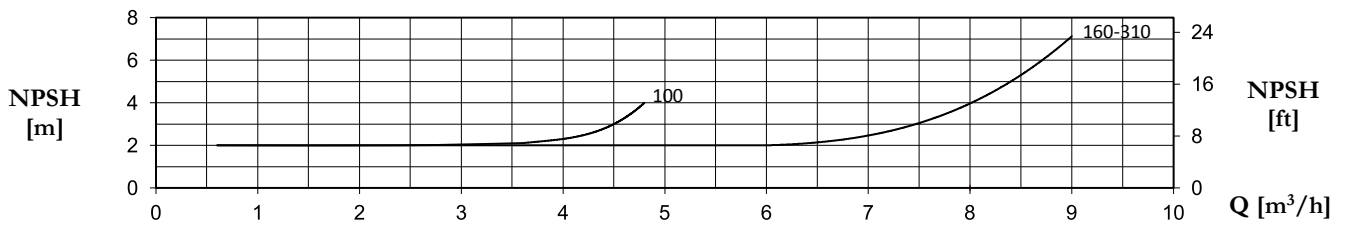
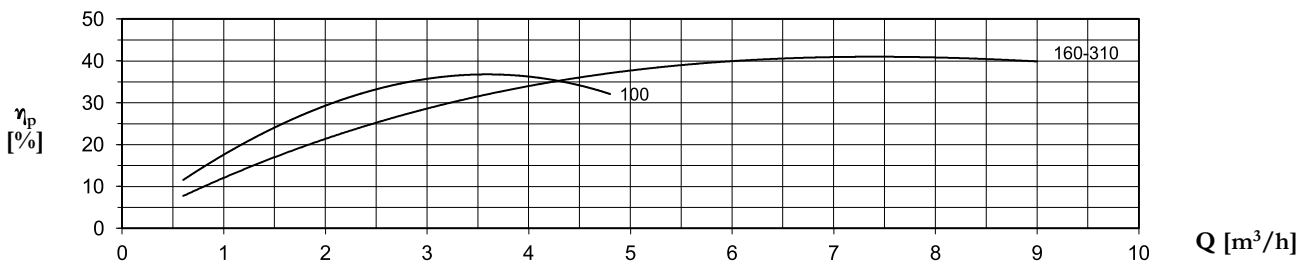
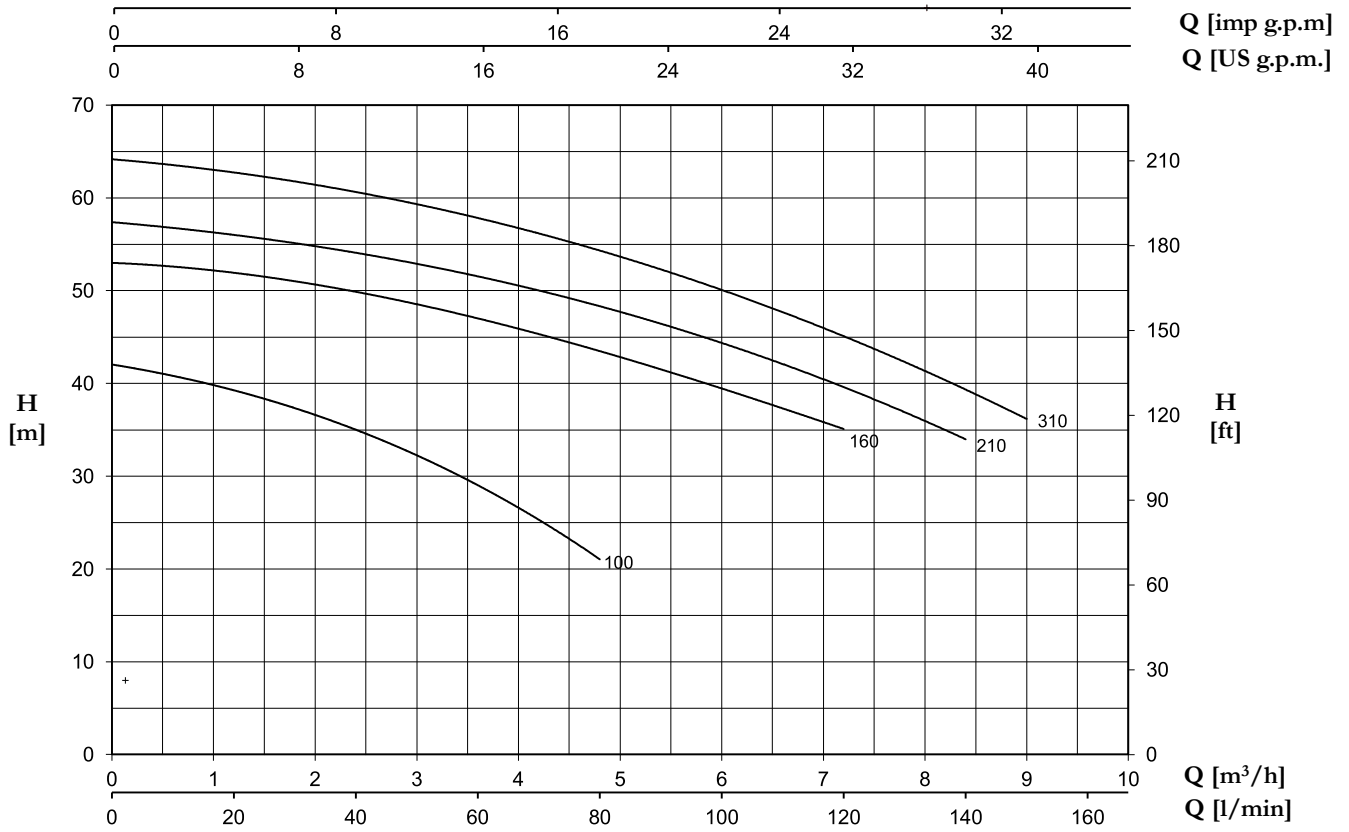

TYPE		P2		P1 (kW)		AMPERE		Q (m³/h - l/min)										
1~	3~					1~	3~	0	0,6	1,2	1,8	2,4	3,6	4,8	6	7,2	8,4	9
H (m)																		
CB 100	CBT 100	1	0,74	1,17	1,15	5,4	2,4	42	40,8	39,4	37,4	34,7	29,2	21	-	-	-	-
CB 160	CBT 160	1,5	1,1	2,30	2,20	10,2	4,1	53	52,5	52	51	50	46,9	43,3	39,7	35	-	-
CB 210	CBT 210	2	1,5	2,60	2,45	11,5	4,8	57,3	56,9	56	55,1	54	51,5	48,4	44,4	39,5	34	-
CB 310	CBT 310	3	2,2	2,9	2,80	13,2	5,2	64	63,5	63	61,9	60,6	57,7	54,1	50	45,4	39,4	36

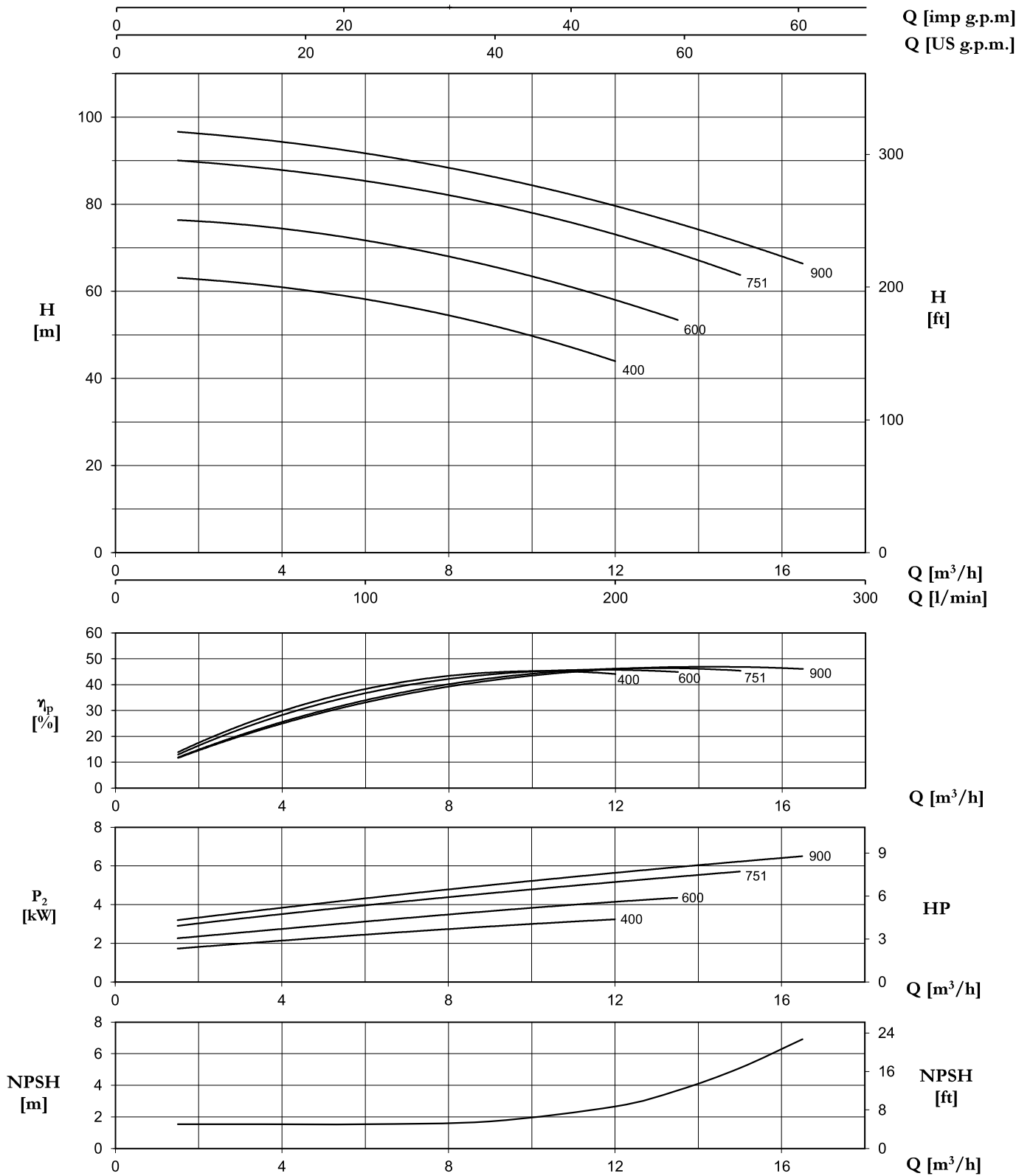

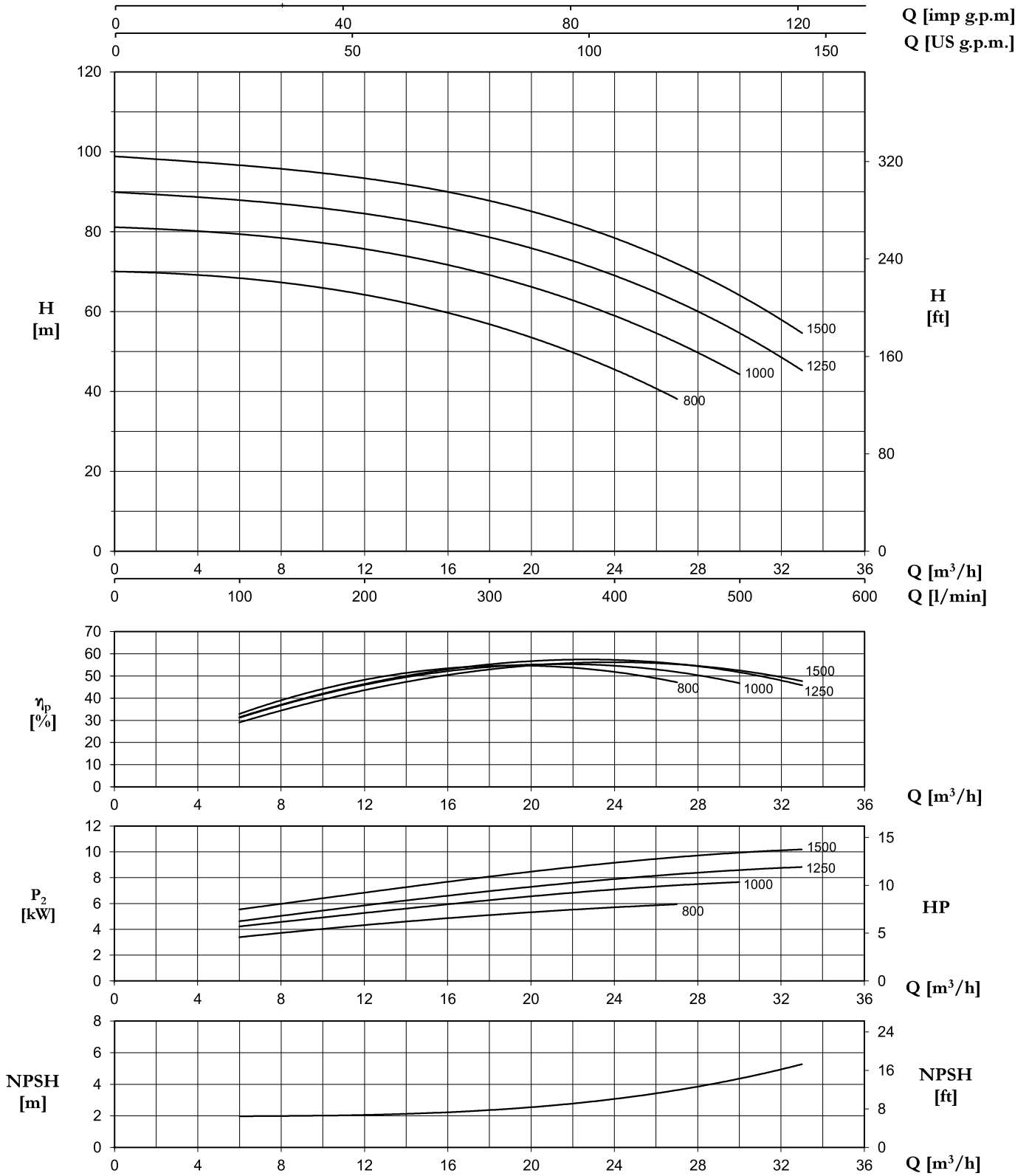

TYPE		P2		P1 (kW)		AMPERE		Q (m³/h - l/min)											
1~	3~	(HP)	(kW)	1~	3~	1~	3~	0	1,5	3,0	4,5	6,0	7,5	9,0	10,5	12	13,5	15,0	16,5
						50 Hz	3x400 V 50 Hz	0	25	50	75	100	125	150	175	200	225	250	275
						H (m)													
CB 400	CBT 400	4	3	3,7	3,8	16,4	6,7	63,6	63,1	62,0	60,3	58,2	55,5	52,3	48,4	43,9	-	-	-
CB 600	CBT 600	5,5	4	5,2	5,0	23,3	9,1	76,9	76,4	75,4	73,8	71,7	69,0	65,9	62,1	58,0	53,4	-	-
-	CBT 751	7,5	5,5	-	6,5	-	11,5	90,7	90,0	88,9	87,3	85,3	82,9	80,1	76,8	73,1	68,8	63,7	-
-	CBT 900	10	7,5	-	7,3	-	13,3	97,5	96,6	95,4	93,7	91,7	89,2	86,5	83,3	79,8	75,2	71,2	66,4

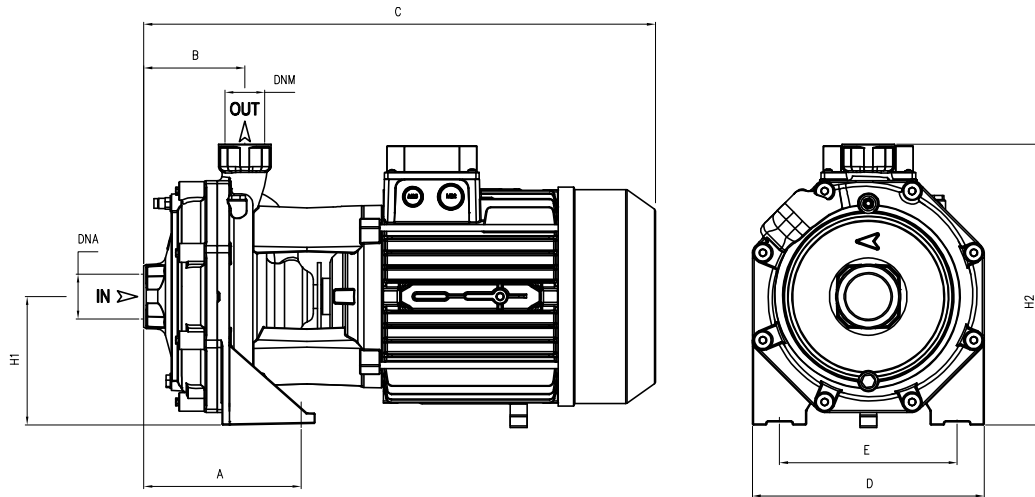

TYPE	P2		P1 (kW)	AMPERE	Q (m³/h - l/min)							
				3~	0	6	12	18	24	27	30	33
					3~	0	100	200	300	400	450	500
3~	(HP)	(kW)	3~	3x400 V 50 Hz	H (m)							
CBT 800	7,5	5,5	6,7	11,1	70,0	68,5	63,9	57,1	45,3	38,2	-	-
CBT 1000	10	7,5	8,5	13,9	80,7	80,4	75,0	68,5	59,7	52,6	43,7	-
CBT 1250	12,5	9,2	9,8	16,3	89,5	88,8	84,1	77,7	69,7	63,0	54,2	45,1
CBT 1500	15	11	11,2	18,6	98,3	97,8	93,5	85,7	78,9	73,3	64,0	54,0



TYPE	DIMENSIONS (mm)													
	A	B	C	D	E	H1	H2	DNA	DNM	I	L	M		
CB 100	122	72	328	180	140	98	228	1" G	1" G	350	195	265	15,5	
CB 160	115	82	385	210	170	110	265	1"1/4 G	1" G	405	225	295	25	
CB 210	115	82	385	210	170	110	265	1"1/4 G	1" G	405	225	295	26	
CB 310	115	82	385	210	170	110	265	1"1/4 G	1" G	405	225	295	30	
CB 400	145	95,5	463	266	212	135	305	1"1/2 G	1"1/4 G	500	285	330	48,0	
CB 600	145	95,5	463	266	212	135	305	1"1/2 G	1"1/4 G	500	285	330	52,0	
CBT 751	145	95,5	480	266	212	135	305	1"1/2 G	1"1/4 G	500	285	330	60,0	
CBT 900	145	95,5	480	266	212	135	305	1"1/2 G	1"1/4 G	500	285	330	XX	
CBT 800	190	120	605	275	210	150	330	2" G	1"1/4 G	670	300	390	78	
CBT 1000	190	120	605	275	210	150	330	2" G	1"1/4 G	670	300	390	86	
CBT 1250	190	120	645	275	210	150	330	2" G	1"1/4 G	670	300	390	91,5	
CBT 1500	190	120	645	275	210	150	330	2" G	1"1/4 G	670	300	390	95,5	

TYPE				
	TRUCK		CONTAINER	
	PALLET (cm)	N° pumps	PALLET (cm)	N° pumps
CB 100	90x110x145	65	90x110x195	91
CB 160-310	85x110x130	40	85x110x190	60
CB 310 M	85x110x150	24	85x110x180	30
CB 400-900	80x120x150	24	80x120x180	30
CBT 800-1500	100x120x140	18	100x120x185	24